

## K1 Softline VK 6 Port Radiator

K1

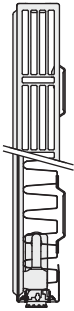

### Top View

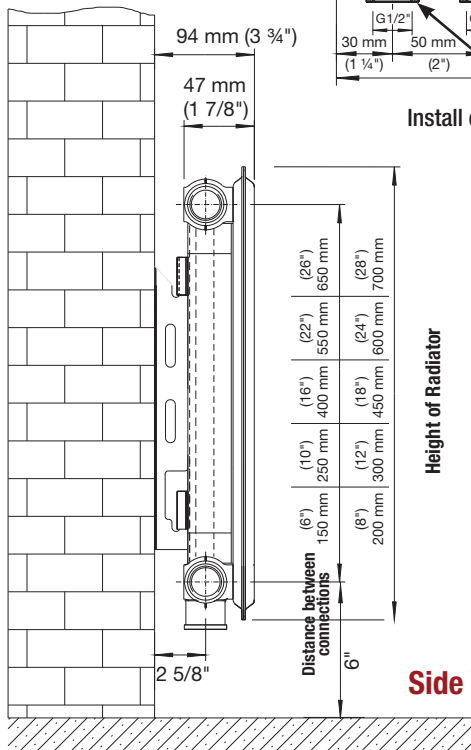

Install chrome plugs provided

### Back View

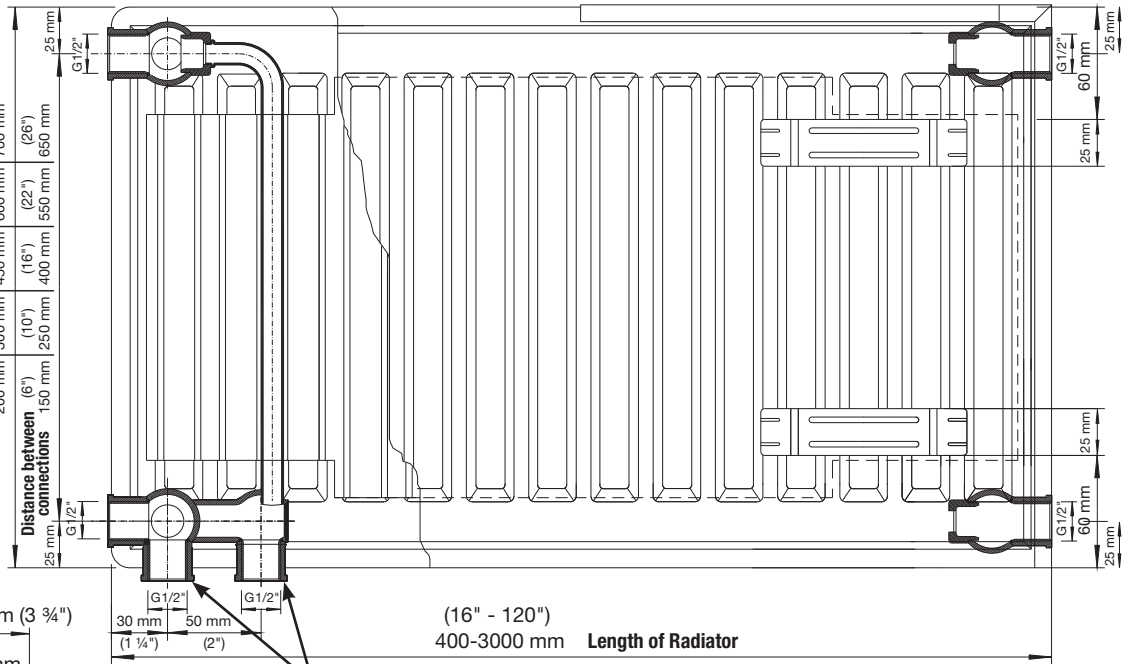

- 2 brackets for radiators 16" (400 mm) - 64" (1600 mm) long
- 3 brackets for radiators 72" (1800 mm) - 120" (3000 mm) long

### Lug Positions - K1 Only

K1		
LENGTH	A	B
400 mm (16")	117 (4 5/8")	N/A
500-1600 mm (20"- 64")	150 (6")	N/A
1800-3000 mm (72"-120")	150 (6")	17 (5/8")

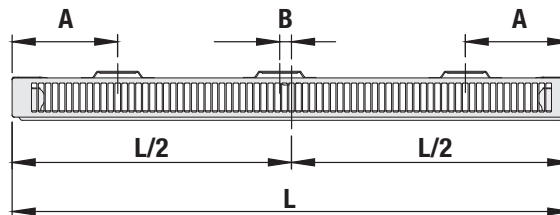

### Side View

Double Angle Shut off Valve



PART# V-1376612-C (Copper)  
V-1376612-P (PEX)

Double Straight Shut off Valve



PART# V-1376602-C (Copper)  
V-1376602-P (PEX)

Thermostatic Head M30



PART# V-1920068

Double Escutcheon



PART# V-1300350

# K2 Softline VK 6 Port Radiator

**NEW! K2 Softline VK 6 Port Radiator installation - Comes with J Brackets** 35

## K2 Softline VK 6 Port Radiator with J Bracket

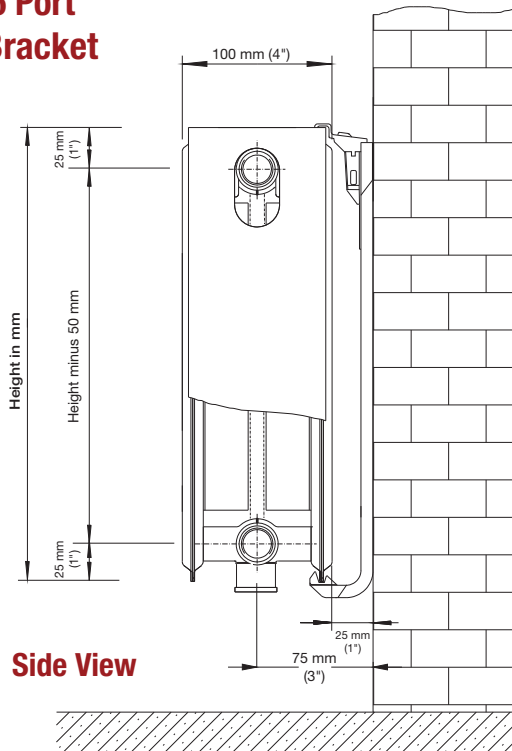
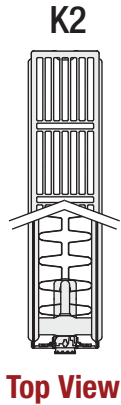

### K2 Only

### J-Bracket

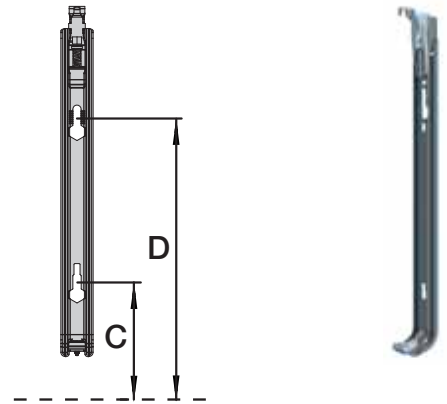

	H	200	300	450	600	700	900
K2	C	64	64	64	64	64	64
	D	90	190	340	490	590	790

Measurements above are in mm

## Piping Options

All plastic test plugs must be replaced with valves and the metals plugs provided in the supplied hardware pack. Including the double ports underneath the radiator.

L	400	500	600	700	800	900	1000	1100	1200	1400	1500	1600	1800	2000	2200	2400	2600	2800	3000
E	145	195	245	295	345	395	445	495	545	645	695	745	845	945	1045	1145	1245	1345	1445

Measurements above are in mm

